

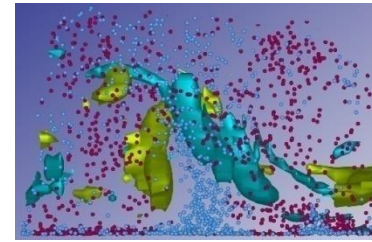

Università degli Studi di Udine
Dip. Politecnico Ingegneria & Architettura



Pneumatic Conveying

M.Campolo

Design of Industrial Plants 2018



Problem

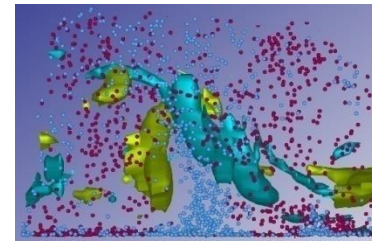

Transfer particulate solids from one point to another



A boat being loaded at Pier 86 Grain Terminal (Seattle)



Belts conveyor to load/unload sulphur



Krupp coal stacker (RTCA Kestrel Mine, Queensland)



Objective

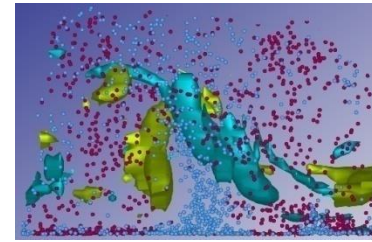

Transfer the solid phase **continuously** using a flux of air (carrier gas)

System initially used to load/unload grains, sands, seeds

System presently used to load chemicals, wood fibers, powders

Under which condition the solids can be transported as suspended matter in the flow? How large is the pressure drop?



Transport system: suction mode

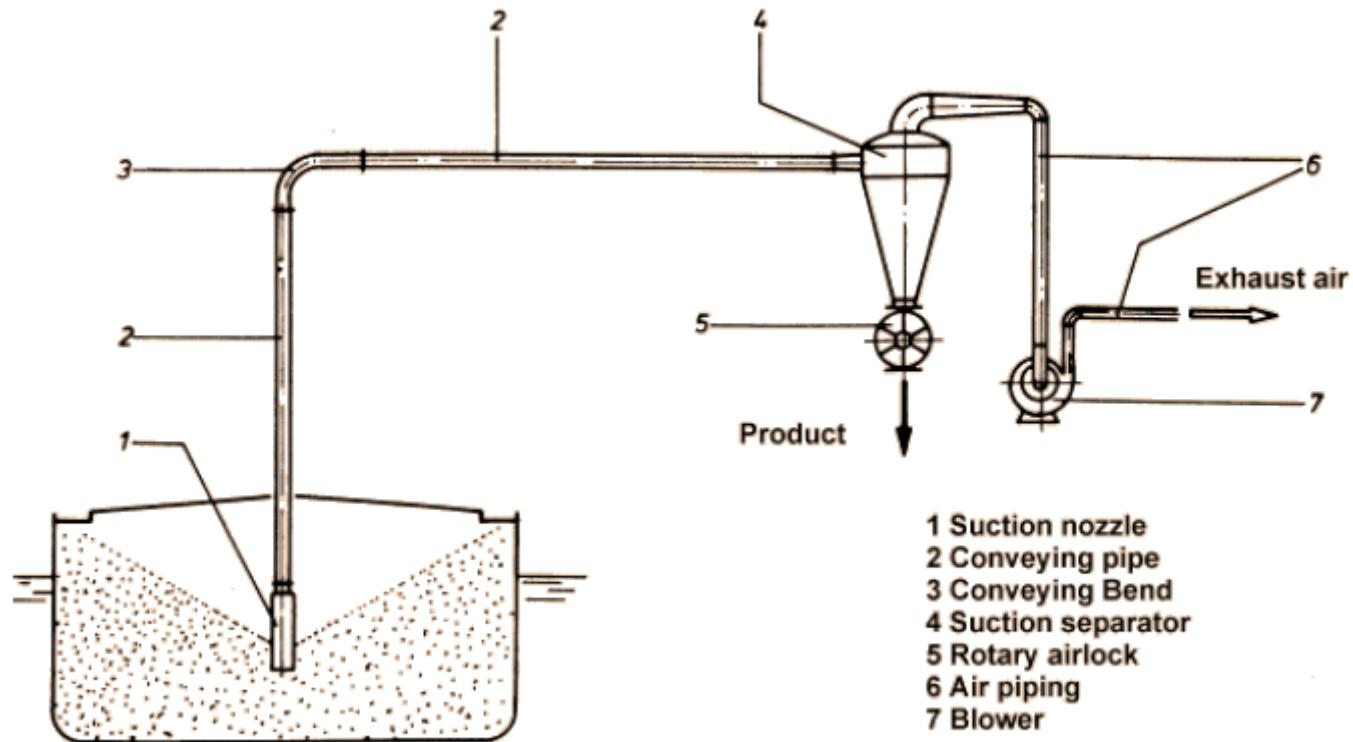
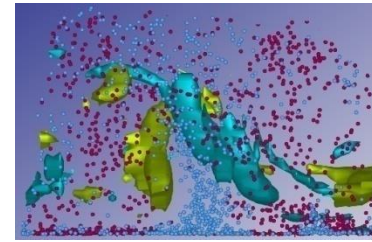

Like in a vacuum cleaner...

Pressure in the line $<$ environmental pressure

→ no risk of leakage, limited loading capacity/transport length



Transport system: pressure mode

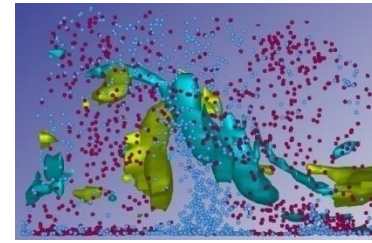

- 1 Blower
- 2 Rotary airlock
- 3 Conveying pipe
- 4 Pipe diverter
- 5 Pressure separator

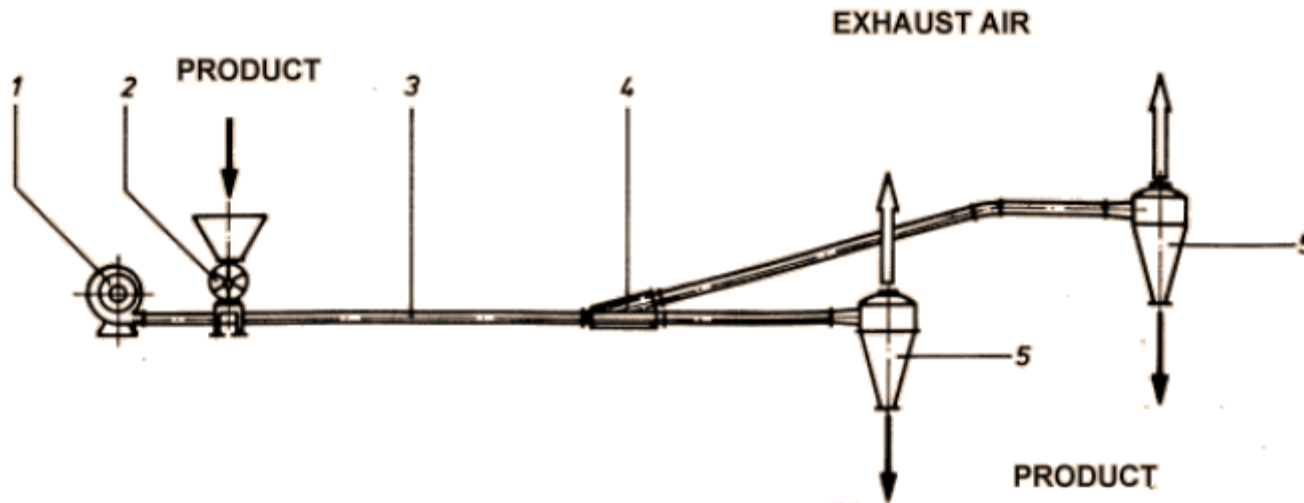

Pressure in the line $>$ environmental pressure
→ Leakage possible, enhanced loading capacity/transport length



Transport system: suction-pressure mode

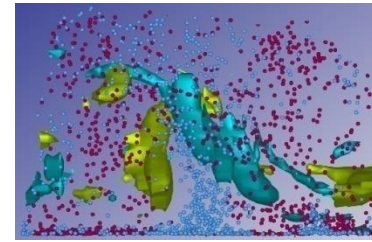

- 1 Suction nozzle
- 2 Suction conveying pipe
- 3 Conveying bend
- 4 Suction separator
- 5 Air piping
- 6 Blower
- 7 Rotary airlock
- 8 Pressure conveying pipe
- 9 Pressure separator

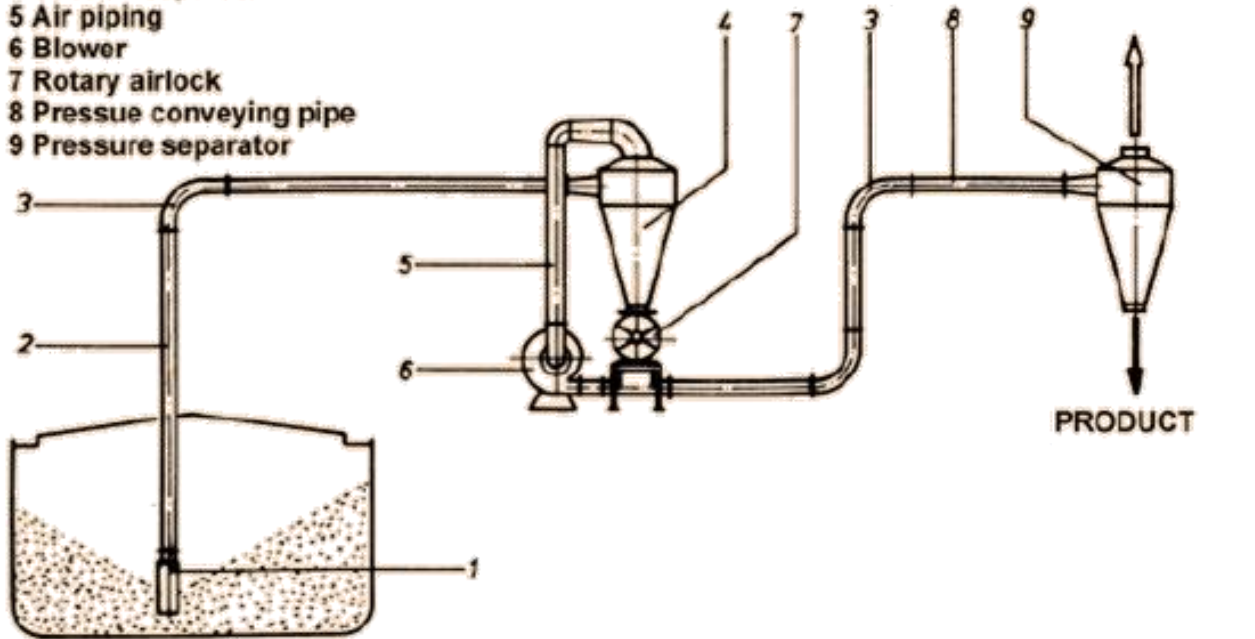



Pipeline characteristics

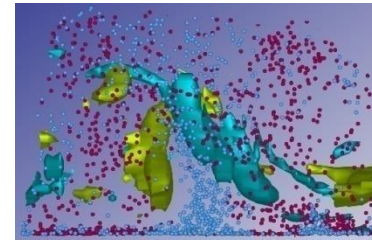

Pipe diameter: 10 mm – 800 mm

Solid flowrate: 1 kg/h – 1000 t/h

Pipe length: 10 m – 1000 m

Air velocity: 10 m/s – 30 m/s

Suction mode: product introduced at a number of points and delivered to a central locations

Pressure mode: product introduced at a single point and delivered to multiple locations (larger throughput)



Flow regimes (vertical pipe)

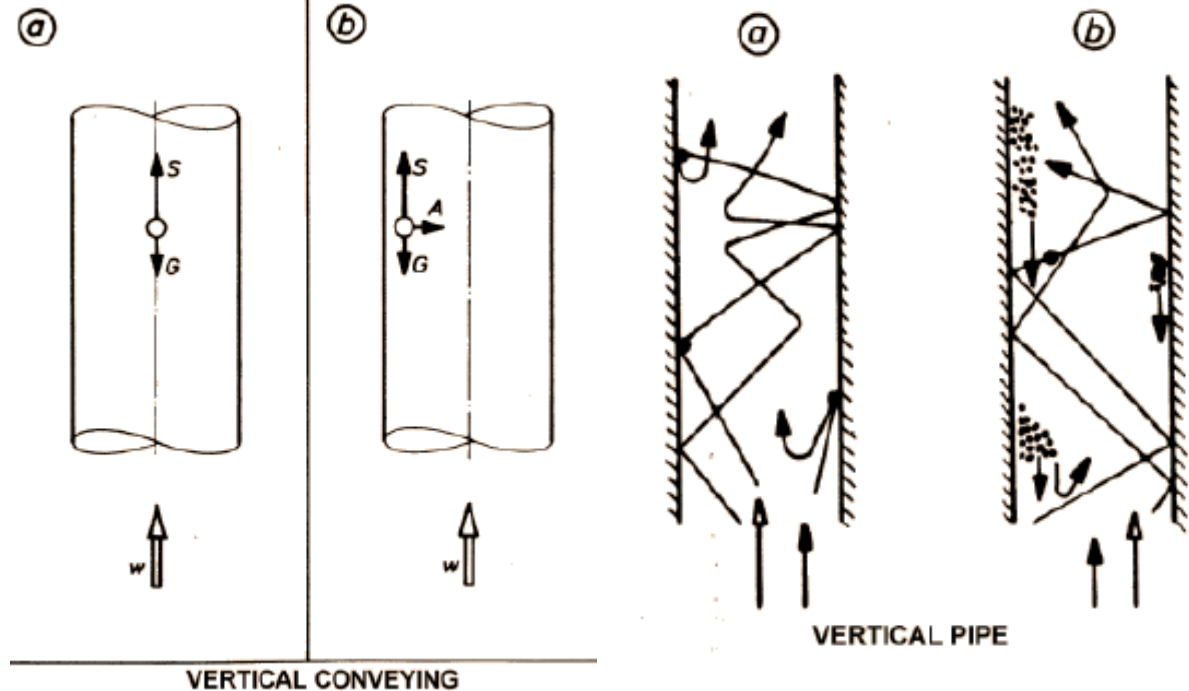
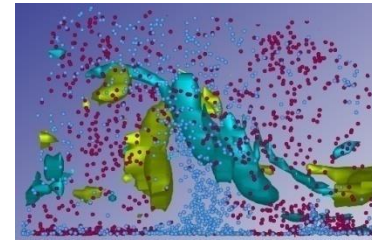

G: gravity force
S: drag force
A: lift force

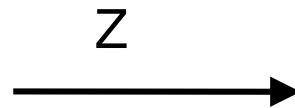

I: inertial force
Fp-p: particle-particle drag
Fp-w: particle-wall drag



Flow regimes (horizontal pipe)

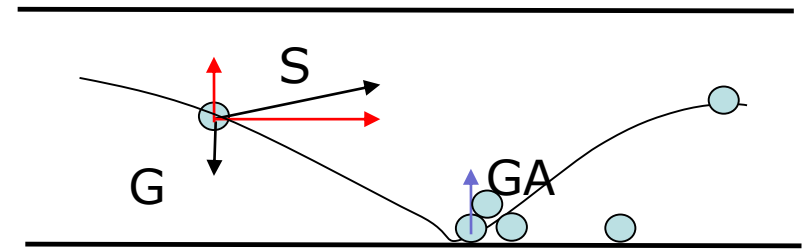
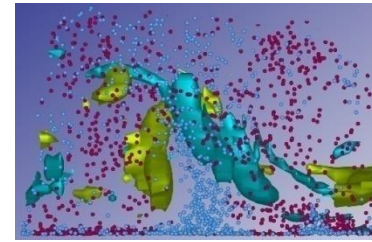

G: gravity force
S: drag force
A: lift force

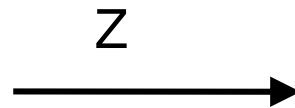

I: inertial force
Fp-p: particle-particle drag
Fp-w: particle-wall drag



Suspension speed: experimental evaluation

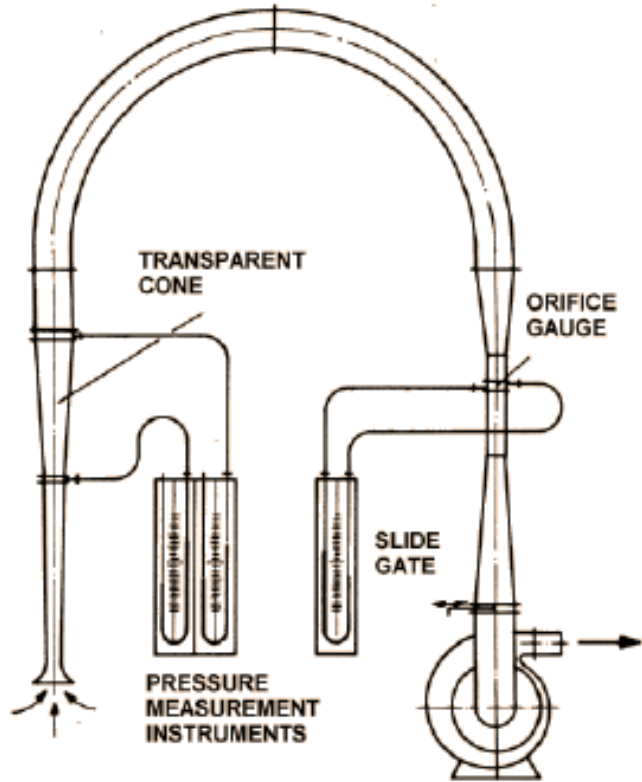
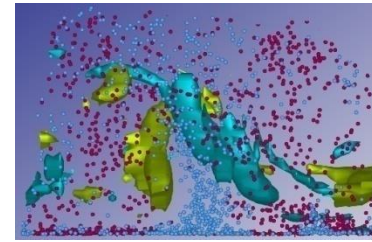

Is a function of:

- Shape
- Size
- Surface roughness (smooth/rough)

Smooth/spherical grains

Fines

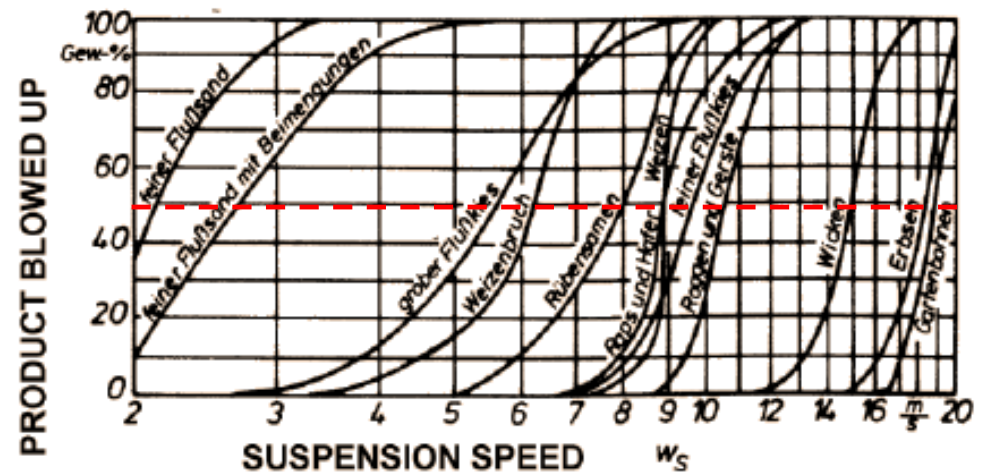



Flow regimes (horizontal pipe)

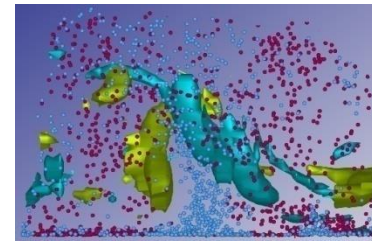

Mass loading (Z) = Solid Mass flow rate / Air mass flow rate

$$Z = \frac{\dot{m}_p}{\dot{m}_g}$$



Dilute regime
 $Z=5$



Dense
suspension
 $Z=20$

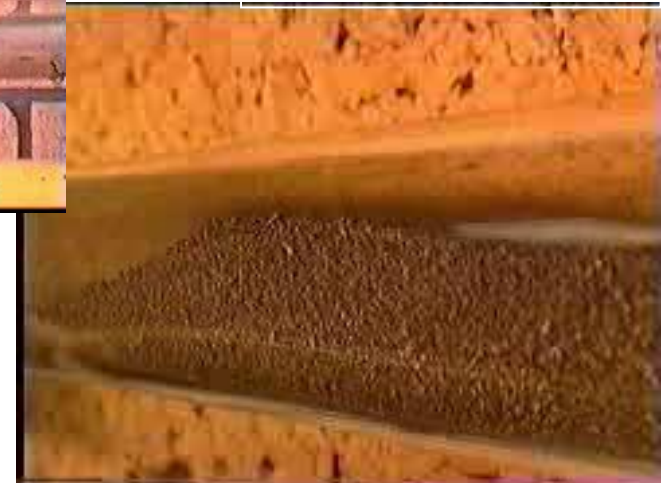



Pressure loss

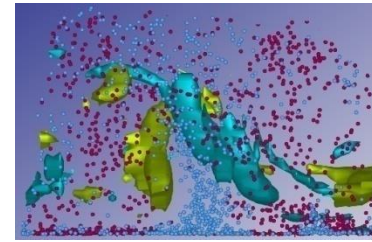

- ΔP_{TOT} depends on
- Gas friction $\Delta P_L \sim w^2$
 - Solid acceleration $\Delta P_R \sim \dot{m}_p w$
 - Blocking forces $\Delta P_F \sim 1/w$

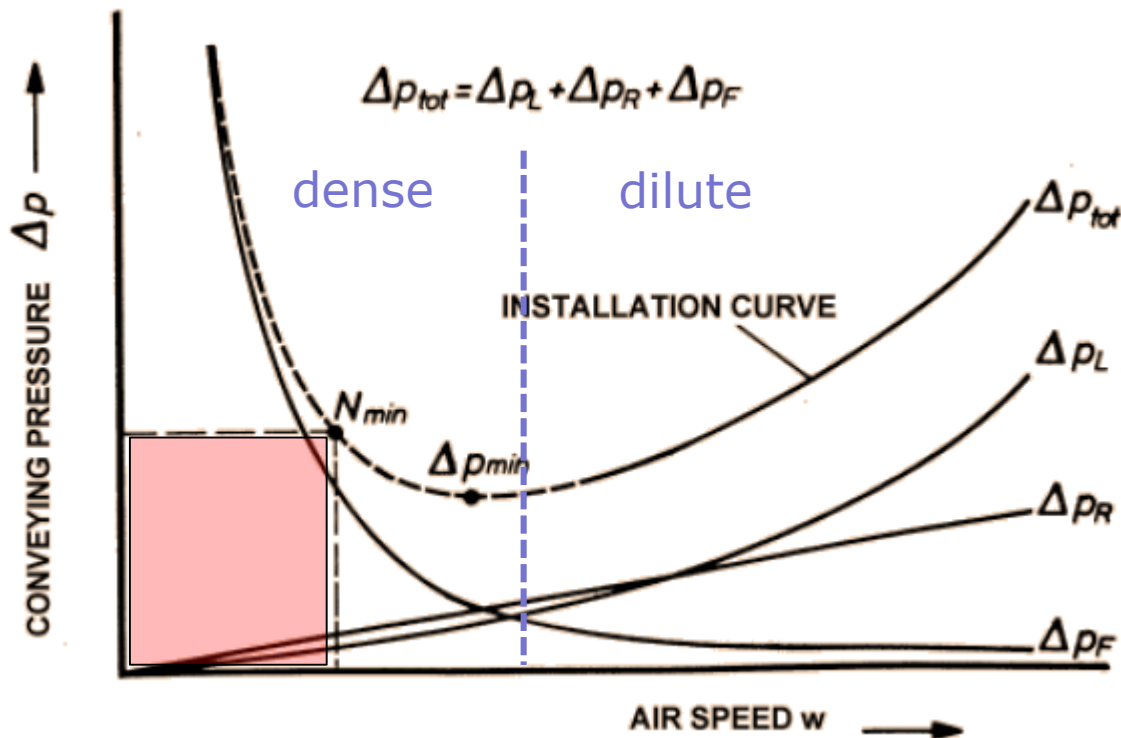

$$P = Q \cdot \Delta P_{TOT} \sim w^3$$



Flow regimes (horizontal)

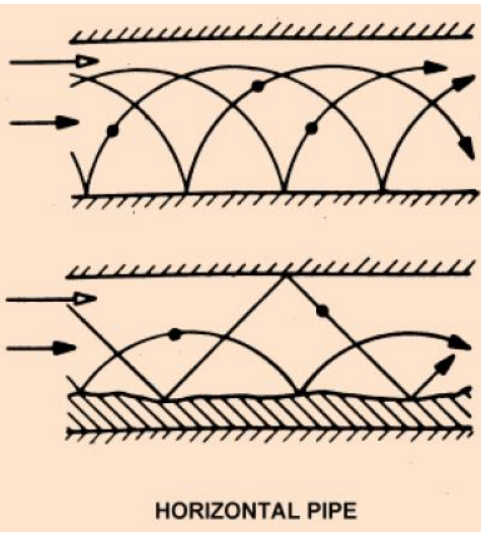
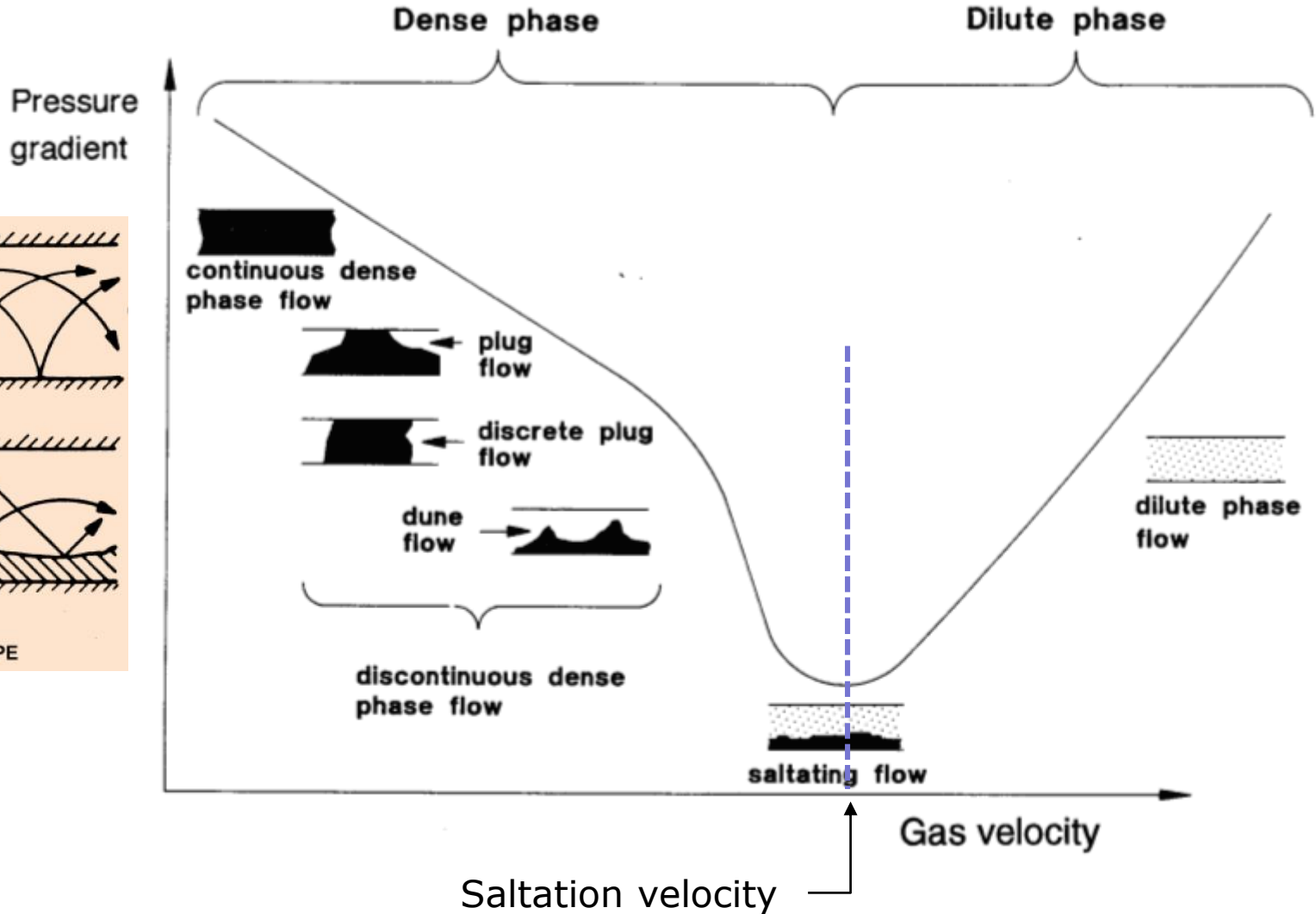
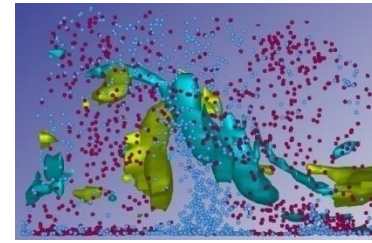



Pressure loss: horizontal pipe

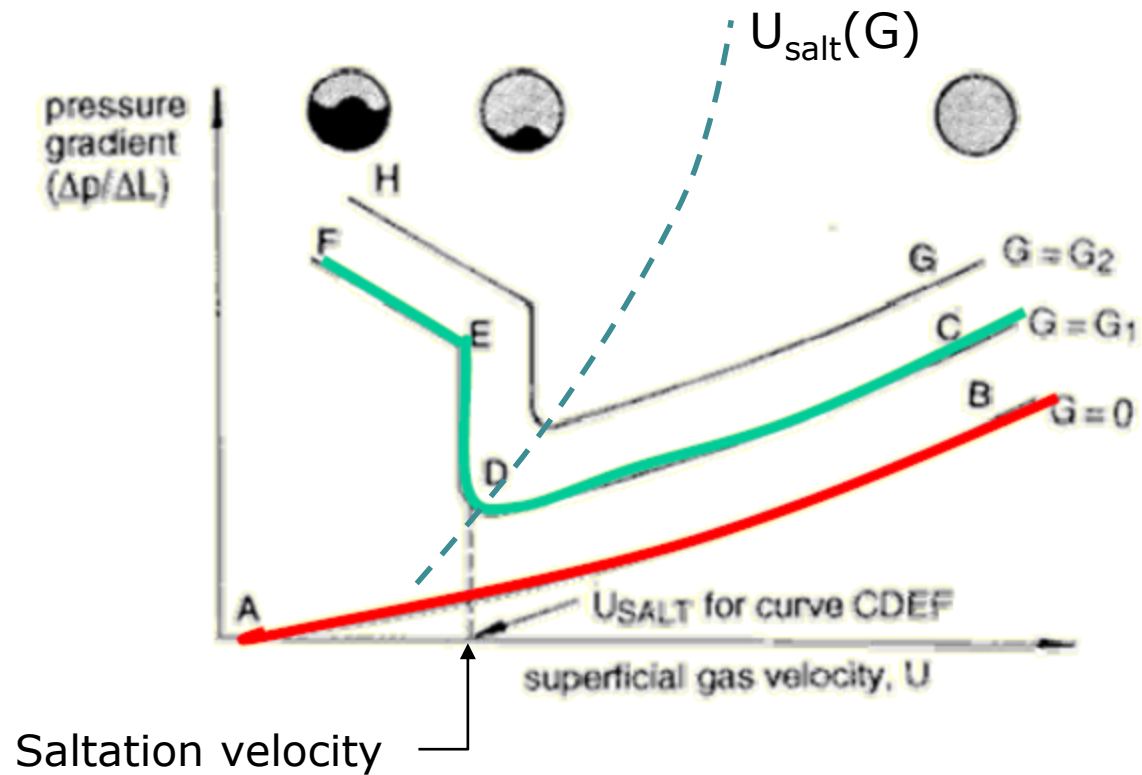
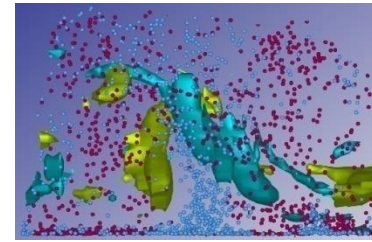

$G = \dot{m}_p = \text{Solid mass flow rate}$

— Gas only

— Gas + solids

$U_{\text{salt}} = \text{minimum velocity to prevent deposition}$



Pressure loss: vertical pipe

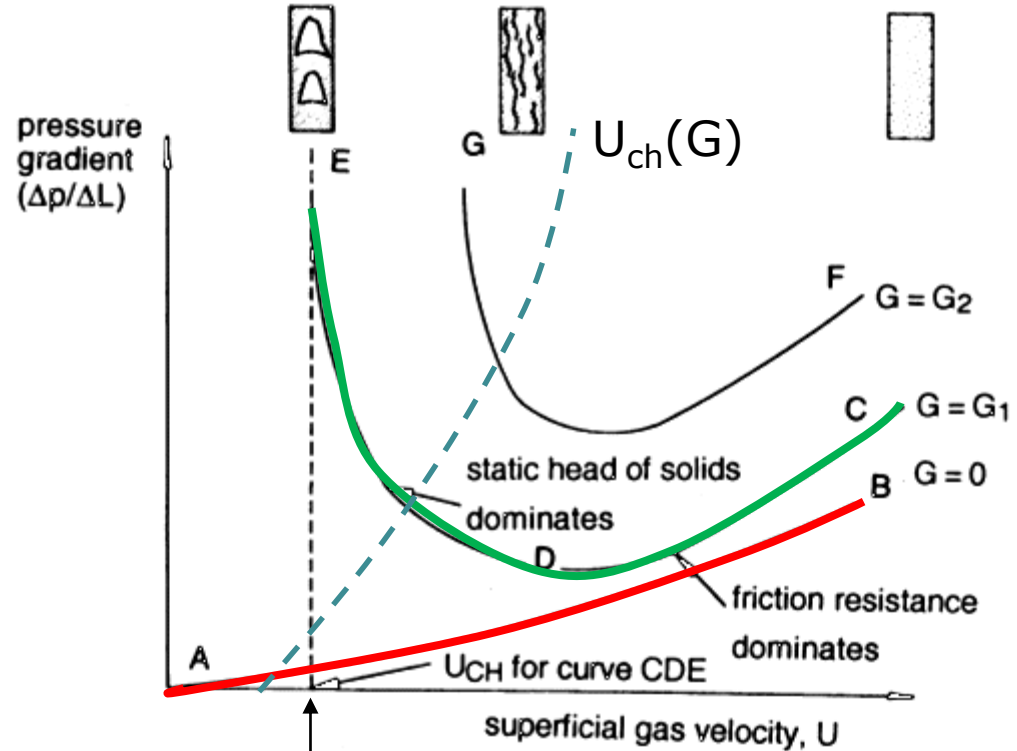
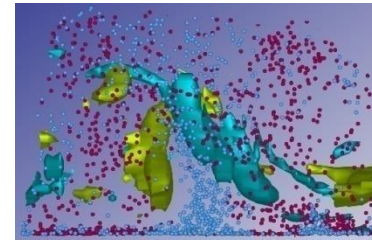

G = solid mass flow rate

U_{ch} = choking velocity

Choking velocity

— Gas only

— Gas + solids

N.B. $U_{g,salt} > U_{ch}$!!!



Pressure drop calculation

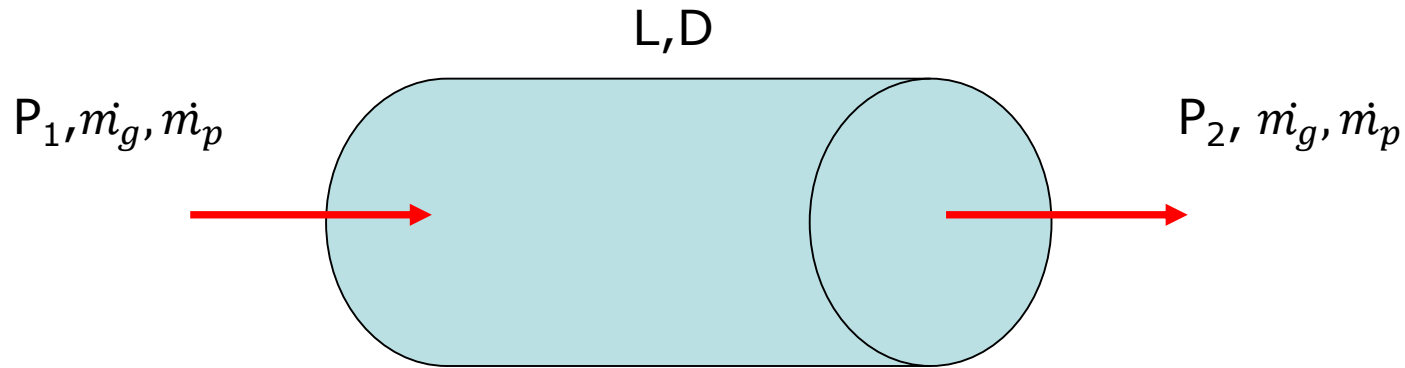
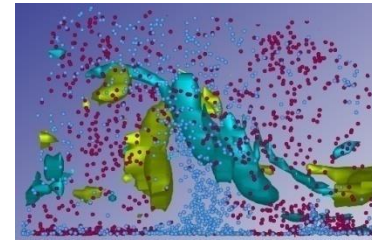

$$P_1 - P_2 = \Delta P_{acc,gas} + \Delta P_{acc,s} + \Delta P_{friction,gas} + \Delta P_{friction,s}$$
$$\left(+ \Delta P_{grav,s} + \Delta P_{grav,gas} \right) \text{ in vertical flow}$$

$U_{g,sup}$, gas superficial velocity

$U_{p,sup}$, solid phase superficial velocity

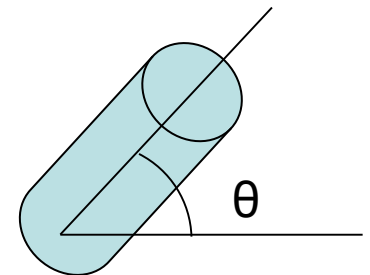



Evaluation of pressure drop

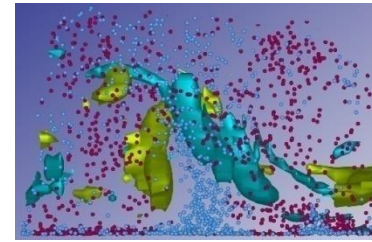

1. Problem data

- Gas properties (M, P, T, μ, ρ)
- Particle properties (ρ_p, D_p)
- Pipeline (L, D)
- Gas and solid flow rates (\dot{m}_p, \dot{m}_g)

2. Evaluation of saltation velocity

$$Z = \frac{\dot{m}_p}{\dot{m}_s} = \frac{1}{10^\delta} Fr^x$$

$$\delta = 1.44 D_p + 1.96 \quad D_p \text{ in mm}$$

$$x = 1.1 D_p + 2.5$$

$$Fr = \frac{U_{g,salt}}{(gD)^{0.5}} \rightarrow U_{g,salt} \rightarrow \rightarrow \text{select } U_g > U_{g,salt}!!!!$$



Evaluation of pressure drop

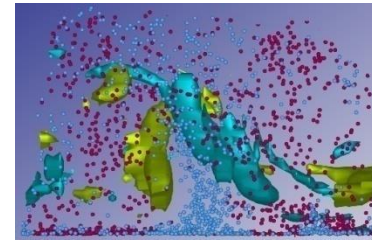

3. Evaluation of surface velocity

$$U_{g,sup} = \frac{\dot{m}_g}{A} \quad \text{Gas velocity (if only phase in pipe)}$$

$$U_{p,sup} = \frac{\dot{m}_p}{A} \quad \text{Particle velocity (if only phase in pipe)}$$

4. Evaluation of volumetric fraction

$$Q_g = \frac{\dot{m}_g}{\rho_g} \quad \varepsilon_g = \frac{Q_g}{Q_g + Q_p} \quad \text{Gas volumetric flowrate \& volume fraction}$$

$$Q_p = \frac{\dot{m}_p}{\rho_p} \quad \varepsilon_p = 1 - \varepsilon_g \quad \text{Particle volumetric flowrate \& volume fraction}$$

5. Evaluation of effective velocity

$$U_{g,eff} = \frac{U_{g,sup}}{\varepsilon_g} \quad \text{Actual velocity of gas}$$

$$U_{p,eff} = \frac{U_{p,sup}}{(1 - \varepsilon_g)} \quad \text{Actual velocity of particles}$$



Evaluation of pressure drop

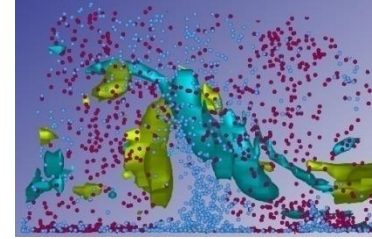

6. Pressure drop for gas and solid acceleration

$$\Delta P_{acc,g} = 0.5 \varepsilon_g \rho_g U_{g,eff}^2$$

$$\Delta P_{acc,p} = 0.5 \rho_p U_{p,eff}^2$$

Wall friction

$$\Delta P_{friction,g} = 2f \frac{L}{D} \rho_g U_{g,eff}^2$$

Gas wall friction

$$f = 0.079 Re^{-0.25}$$

$$Re = U_{g,eff} \rho_g D / \mu$$

$$\Delta P_{friction,p} = f_s Z \frac{L}{2D} \rho_g U_{g,eff}^2$$

Particle-wall and particle-particle friction

$$f_s = 0.082 Z^{-0.3} Fr^{-0.86} Fr_s^{0.25} \left(\frac{D}{D_p}\right)^{0.1}$$

$$Fr = U_{g,eff} / (gD)^{0.5}$$

$$Fr_s = U_{p,sett} / (gD)^{0.5}$$

particle settling velocity

$$U_{p,sett} = g \rho_p D_p^2 / (18\mu)$$



Evaluation of pressure drop

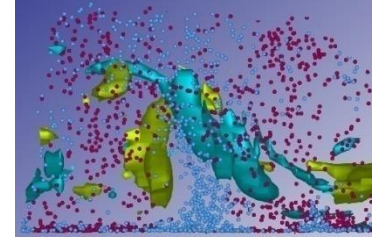

7. Extra terms for changes in pipe elevation

$$\Delta P_{grav,g} = \varepsilon_g \rho_g L \sin \vartheta$$

Pressure loss to lift the gas

$$\Delta P_{grav,p} = (1 - \varepsilon_g) \rho_p L \sin \vartheta$$

Pressure loss to lift the particles

8. Final considerations

Since $U_{ch} < U_{salt} \rightarrow U_{g,sup} = kU_{salt} > U_{salt}$ where $k > 1$
is enough to produce dilute flow

$K=1.5 \div 2$ is large enough to account for errors in the evaluation of U_{salt} due to the empirical correlation used

Any larger velocity would produce dilute flow BUT the pumping power scales with $U_{g,sup}^3$!!!!



Additional pressure loss at bends

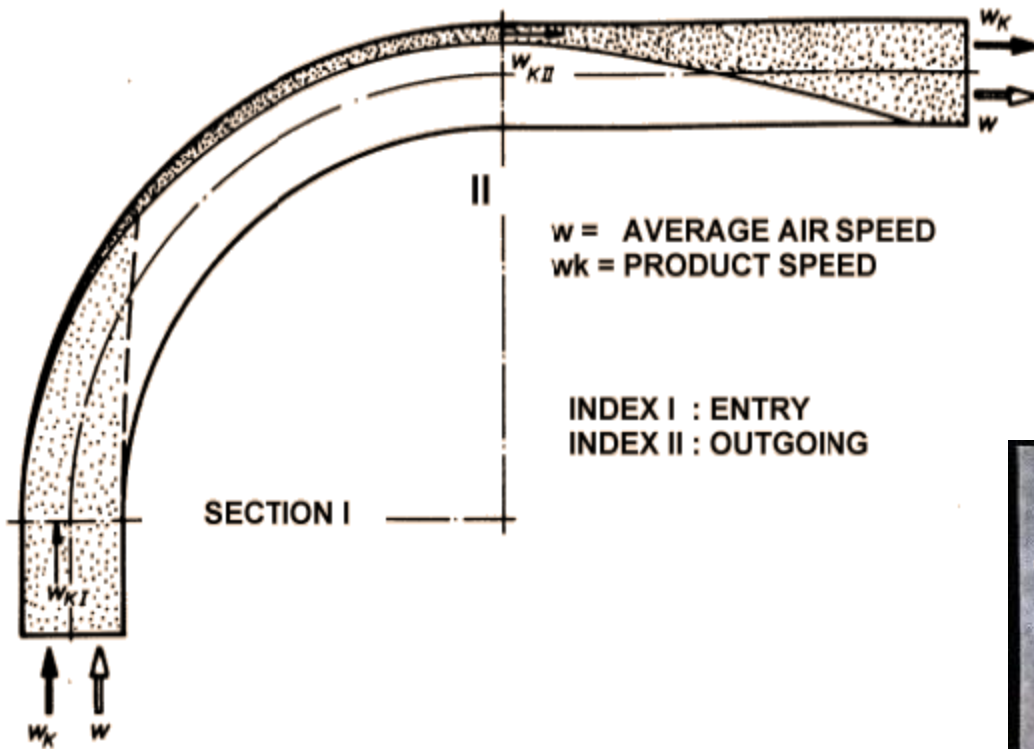
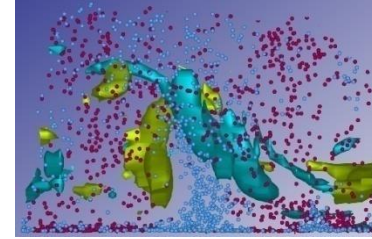

At each bend: due to centrifugal forces particles accumulate on one side of the pipe section, decelerating and losing energy

Severe erosion may be produced by hard particles



- Minimise the N° of bends
- Use large curvature radius



Additional pressure drop due to bends

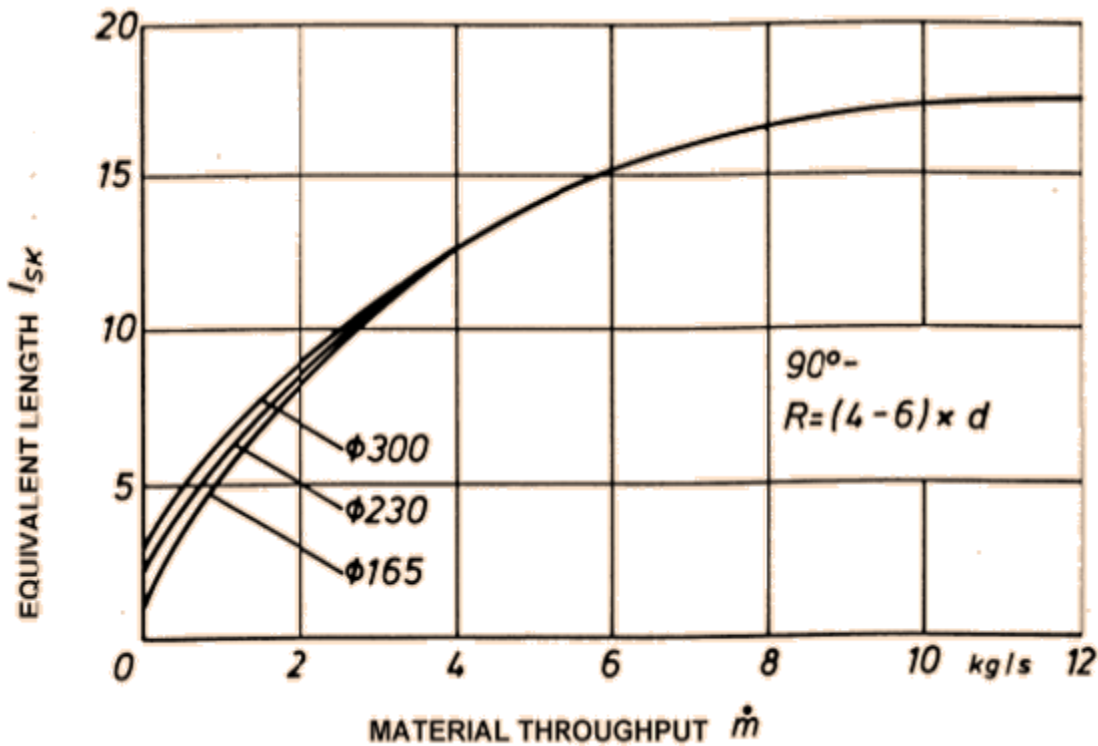
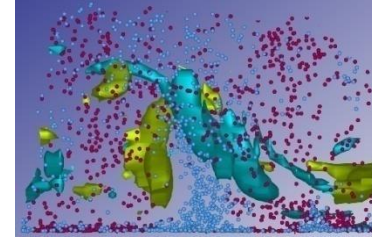

Equivalent length of pipe



R: curvature

D: pipe diameter

$$\Delta P_{\text{Bend}} = 2 f L_{sk} / D \rho w^2$$



References

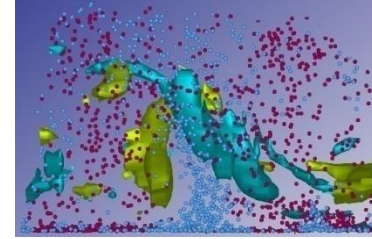

<http://www.erpt.org/retiredsite/014Q/rhoe-00.html>

Introduction to the Theoretical and Practical Principles of
Pneumatic Conveying

SCOTT NEIDIGH, *Neuero Corporation, West Chicago, IL, USA*

Theory and design of dilute phase particle conveying systems

A.T. AGARWALD, *Power handling processing*

Coulson & Richardson, *Chemical Engineering*